

15271.050X

DN50

LX-939

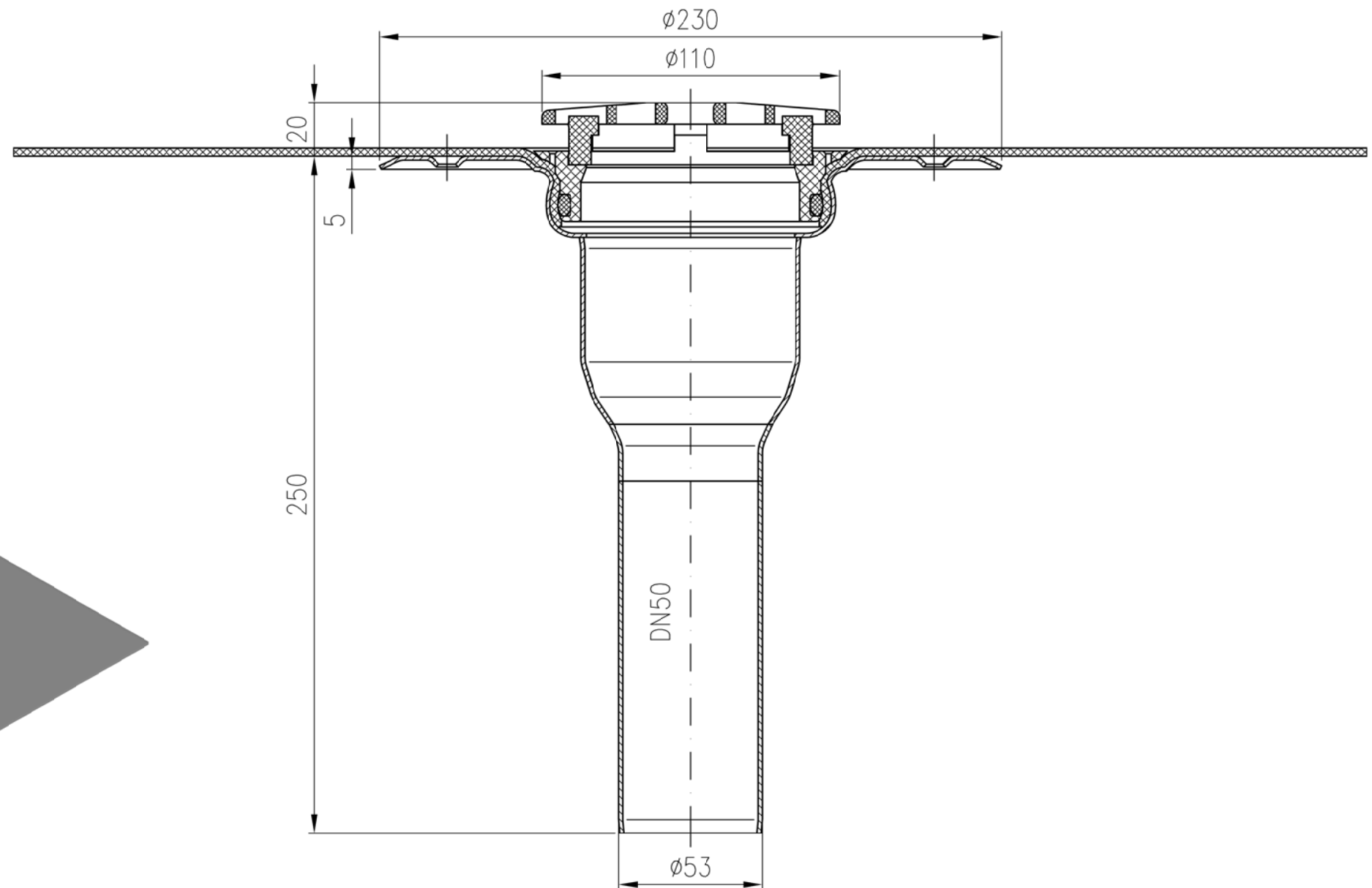
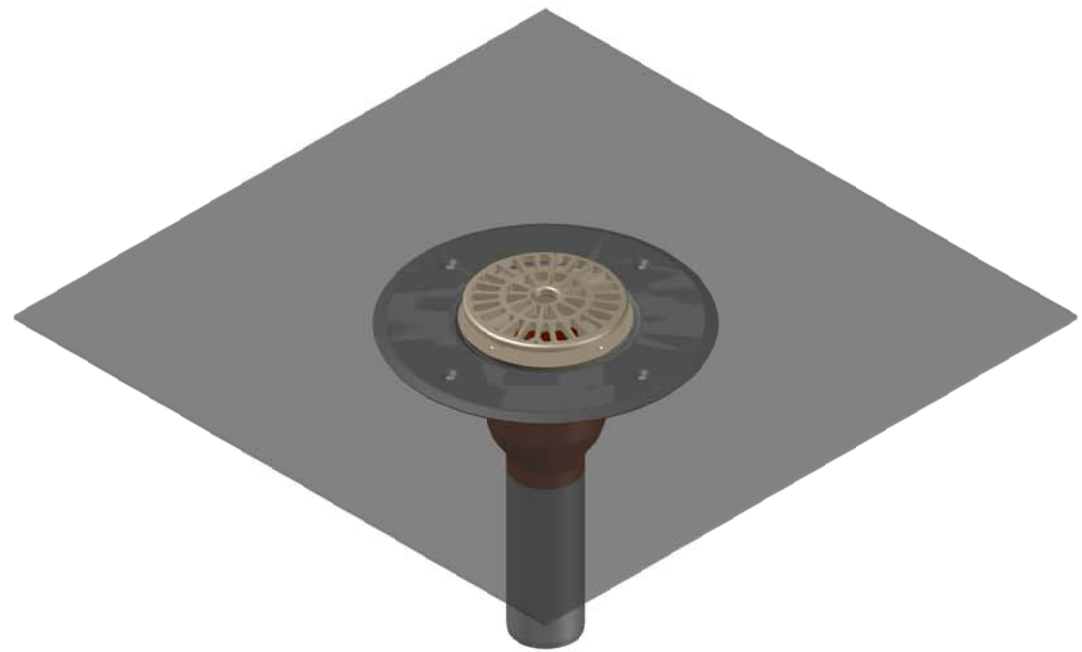

				Maßstab	Zul.Abw.	Benennung	Zeichnungs Nr.
				1:2		System LX 939	LX-939
				2019	Tag	Name	Ersatz für:
				Gez.	19.07.	Koeh	
				Gepr.			ersetzt durch:
				Norm.		LX-939.DWG	
				 Bauvorhaben			
Index	Änderung	Tag	Name				